

Features and Benefits

- Pre-aligned, pre-calibrated detector & spectrograph**
 Motorized, individually factory-calibrated systems – out-of-the-box operation and seamless integration to experimental set-ups
- Image astigmatism correction**
 Optimized toroidal optics for high density multi-track capabilities
- USB 2.0 interface**
 Plug and play connectivity, ideal for laptop operation alongside Andor USB cameras
- Motorized, indexed triple grating turret**
 Easily upgradable in-the-field
- Dual detector outputs**
 For extended wavelength coverage when combining Andor UV-Visible CCD and InGaAs cameras
 Compatible with Andor's range of CCD, ICCD & EMCCD cameras
- Wide range of accessories available**
 The ultimate in modular set-up and in-field upgradability, including:
 - Motorized slits & filter wheel
 - Microscope interfaces
 - Shutters
 - Fibre-optic & lens couplers
 - Multi-way fibre-optic bundles
 - Light sources and optics
- Monochromator capabilities**
 Extract best optical resolution while allowing use of single point detectors with sensitivity up to 12 μm
- Silver-protected coated optics options**
 Most efficient for Near-Infrared detection when used in conjunction with Andor InGaAs cameras and single point detectors InGaAs, PbS, InSb & MCT
- Integrated in EPICS ^{*22}**
 Supported by EPICS control software

High resolution and multi-track performance spectrograph

The Shamrock 500i is the platform of choice for high resolution measurements with outstanding multi-track capabilities, but without compromise in configuration versatility and ease of use. This rugged platform features a comprehensive range of light coupling accessories and gratings, and combines ideally with Andor's market leading CCD, Electron Multiplying CCDs, and InGaAs and Intensified CCDs. Andor's latest addition of single point detectors for scanning monochromator applications up to the LWIR (12 μm) enhances even further the capabilities of this system. State-of-the-art Solis Spectroscopy and Solis Scanning software offer a dedicated and intuitive interfaces for spectrograph, detectors and motorized accessory control as well as easy detection parameter set-up.

Specifications Summary

Resolution with Newton DU940 CCD	
1200 l/mm @ 500 nm	0.07 nm
2400 l/mm @ 300 nm	0.03 nm
Aperture	F/6.5
Focal length	500 mm
Magnification (Vertical @ centre of CCD)	1
Gratings	Interchangeable indexed triple turret
Slit widths range (input/output)	Manual or motorized 10 μm to 2.5 mm
Communication	USB 2.0
Wavelength accuracy	0.04 nm
Wavelength repeatability	10 pm

Step-by-Step System Configuration

How to customize the Shamrock 500i:

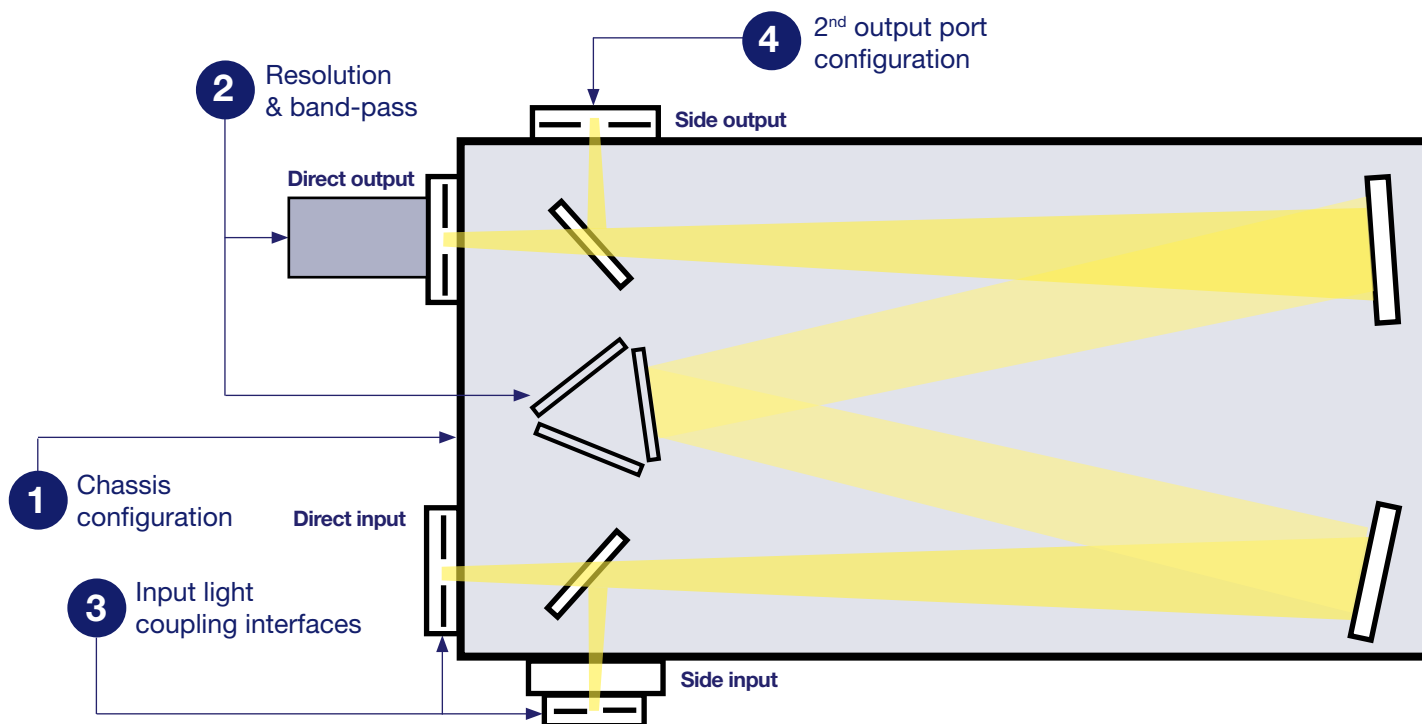

1 Chassis configuration

- Select combination of input and output ports (see page 3 for available options).
- Select type of optics coating required (aluminium + MgF₂ is standard, protected silver coated optics available on request for NIR detection).
- Select purge port option (for improved detection down to 180 nm), and shutter for background acquisition and detectors protection.

2 Resolution & band-pass

- Select the appropriate Shamrock spectrograph platform, giving due consideration to bandpass and spectral range requirement.
- Select gratings and detector to fulfil resolution requirements.
- Select gratings for suitable wavelength coverage.

3 Input light coupling interface

Refer to accessory tree for available configurations (direct coupling, fibre coupling or 3rd party hardware connectivity).

4 2nd exit port configuration

Refer to accessory tree for available configurations, including camera flanges.

5 Software interface

Select either state-of-the-art Solis software or Software Development Kit (SDK) option – please refer to appropriate section for further information.

Step 1 - Chassis Configuration

Ordering Information

Model	Side input port	Direct input port	Direct output port	Side output port	Motorized flipper mirror
SR-500i-A	Manual slit	-	Camera	-	-
SR-500i-B1	Manual slit	-	Camera	Manual slit	√
SR-500i-B2	Manual slit	-	Camera	Camera	√
SR-500i-C	Manual slit	Manual slit	Camera	-	√
SR-500i-D1	Manual slit	Manual slit	Camera	Manual slit	√
SR-500i-D2	Manual slit	Manual slit	Camera	Camera	√
SR-500i-XX-SIL	Protected silver coated optics options for models shown above (replace X with relevant model number)				

Optics Coatings Reflectivity Graph

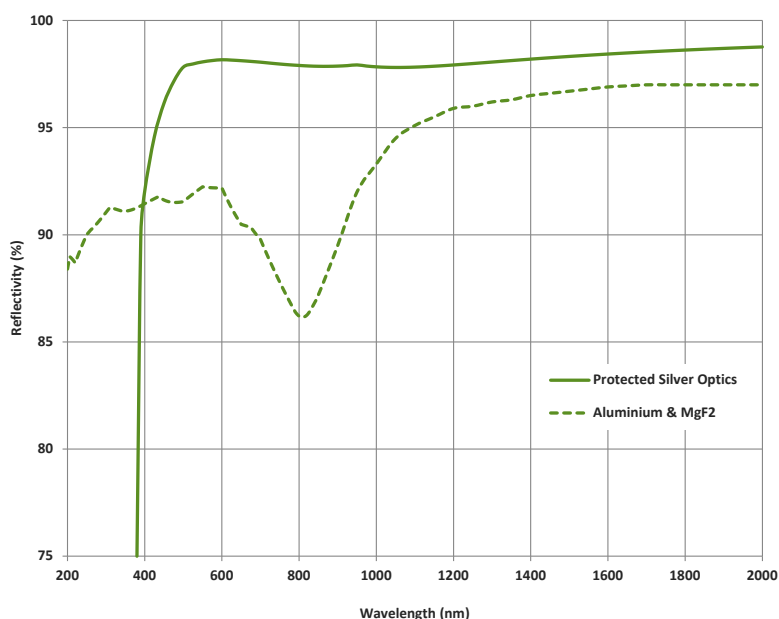

The graph shows the standard Al + MgF₂ optics coatings reflection efficiency versus wavelength.

Protected silver coated optics option is also available on request for maximum efficiency in the NIR region and is recommended for working with Andor iDus InGaAs detectors or IR single-point detectors, such as MCT, PbS and InSb.

When choosing protected silver coatings, it is strongly recommended to also order **protected silver coated gratings** for maximum efficiency throughout the system.

Chassis Accessories

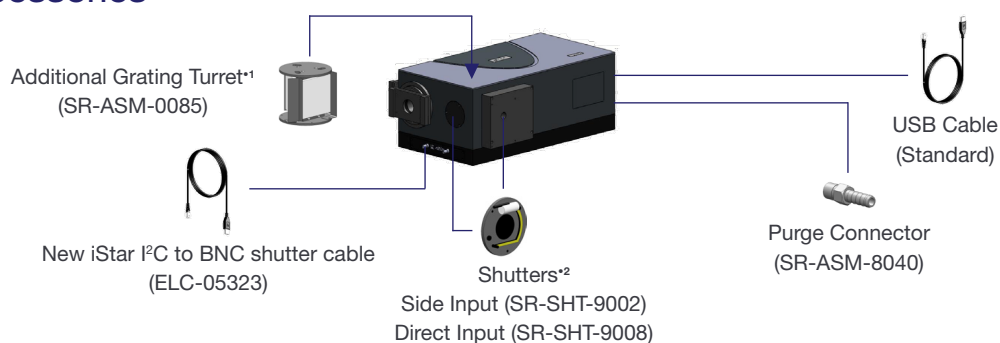

Step 2a - Choosing The Right Platform vs Dispersion Requirements

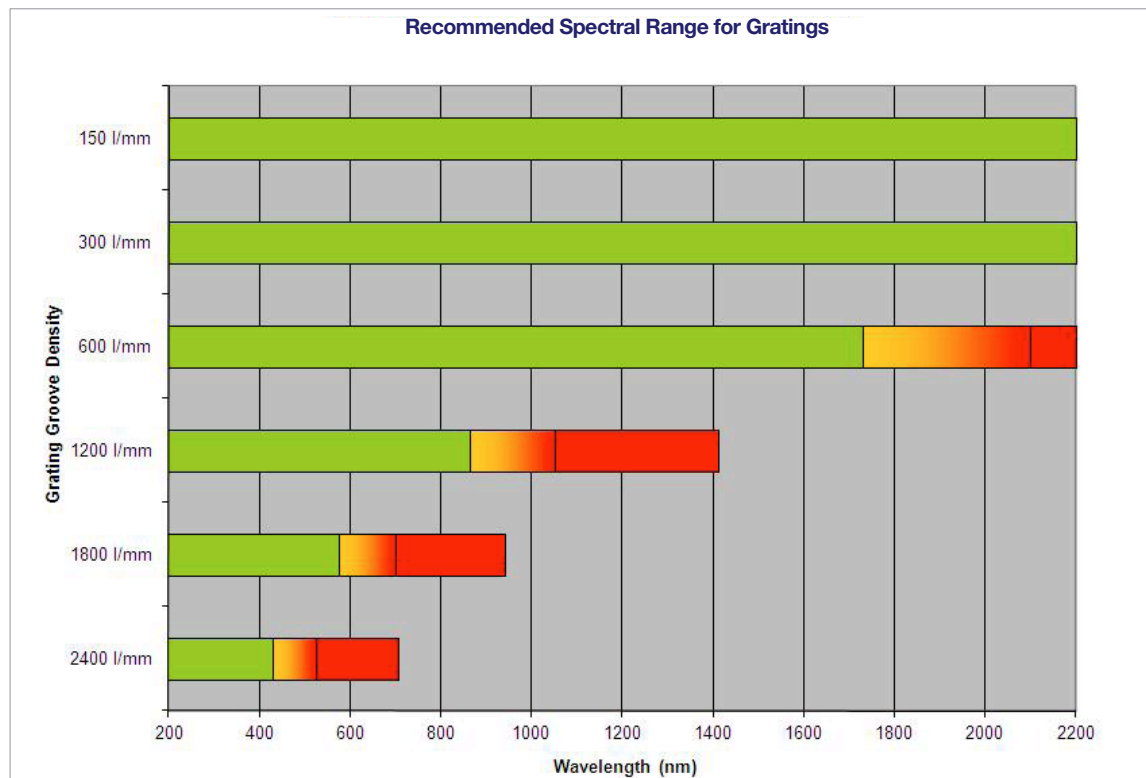

Resolution calculator

andor.com/calculators

Green

Aberration-free region

Orange

Possible impact on system resolution

Red

Likely impact on system resolution

Czerny-Turner spectrographs are designed to provide the best optical performance for a range of grating angles as reflected on the green parts of the graph above. Outside this range, the spectral lines may exhibit a degree of optical aberration (such as coma), which will become more prominent at the steeper angles. These configurations are reflected by the orange to red scales on the graph. In these regions, consideration should be given to higher spectrograph focal length models with lower groove density gratings to achieve the desired resolution.

	Grating (l/mm)					
	150	300	600	1200	1800 (Holo)	2400 (Holo)
Kymera 193i						
Bandpass (nm) ^{*3,5}	902	445	215	98	56	46 ^{*6}
Resolution (nm) ^{*4,5}	1.96	0.96	0.47	0.21	0.12	0.10 ^{*6}
Kymera 328i						
Bandpass (nm) ^{*3,5}	600	297	144	67	39	32 ^{*6}
Resolution (nm) ^{*4,5}	0.88	0.43	0.21	0.10	0.06	0.05 ^{*6}
Shamrock 500i						
Bandpass (nm) ^{*3,5}	357	177	86	40	26	19 ^{*6}
Resolution (nm) ^{*4,5}	0.52	0.26	0.13	0.06	0.04	0.03 ^{*6}
Shamrock 750						
Bandpass (nm) ^{*3,5}	242	120	59	28	18	14 ^{*6}
Resolution (nm) ^{*4,5}	0.35	0.18	0.09	0.04	0.03	0.02 ^{*6}

Where aberration is a concern for a particular experimental set-up, the table above shows resolution and band-pass performance for a variety of alternative configurations. This should be used in conjunction with the graph above to assist in selecting the most appropriate Kymera or Shamrock spectrograph platform to meet resolution and band-pass needs, whilst minimising the risk of potential aberration.

Step 2b - Choosing The Right Grating vs Resolution & Band-pass

The Shamrock 500i features an innovative triple grating turret, designed to offer flexibility and control over your choice and interchange of gratings. The triple grating turret can be easily and speedily removed, and replaced by an alternative turret with new gratings. The intelligent design of the 500i means that only a simple offset adjustment is required once the new turret and gratings are added. The 500i is shipped with the grating turret already in place, ensuring your system is ready for use straight out of the box. Additional grating turrets are available with up to three pre-installed gratings (see below for details). If the grating you require is not on the list, please contact Andor for further details. Additional grating turrets (part number SR-ASM-0085) can also be supplied on request.



Lines/mm	Blaze (nm)	Nominal dispersion (nm/mm) ^{*7}	Bandpass (nm) ^{*3,*7}	Resolution (nm) ^{*4,*7,*10}	Peak efficiency (%)	Andor part number	Maximum recommended wavelength (nm)	Maximum attainable wavelength (nm)
150	300	12.96	358	0.53	72	SR5-GRT-0150-0300	6915	11310
150	500	12.91	357	0.52	73	SR5-GRT-0150-0500		
150	800	12.83	355	0.52	80	SR5-GRT-0150-0800		
150	1250	12.69	351	0.51	84	SR5-GRT-0150-1250		
150	2000	12.43	344	0.50	88	SR5-GRT-0150-2000		
300	300	6.44	178	0.26	88	SR5-GRT-0300-0300	3460	5655
300	500	6.38	177	0.26	81	SR5-GRT-0300-0500		
300	1000	6.20	172	0.25	72	SR5-GRT-0300-1000		
300	1200	6.14	170	0.25	92	SR5-GRT-0300-1200		
300	1700	5.92	164	0.24	89	SR5-GRT-0300-1700		
600	300	3.18	88	0.13	84	SR5-GRT-0600-0300	1730	2830
600	500	3.11	86	0.13	72	SR5-GRT-0600-0500		
600	1000	2.88	80	0.12	72	SR5-GRT-0600-1000		
600	1200	2.77	77	0.11	88	SR5-GRT-0600-1200		
600	1900 (@1600) ^{*8}	2.24 2.49	62 69	0.09 ^{*9} 0.10	88	SR5-GRT-0600-1900		
1200	300	1.54	42	0.06	72	SR5-GRT-1200-0300	865	1415
1200	500	1.44	40	0.06	81	SR5-GRT-1200-0500		
1200	1000	1.07	30	0.05 ^{*9}	69	SR5-GRT-1200-1000		
1200	@ 800 ^{*8}	1.25	34	0.05	69			
1200	Holographic (500 nm peak)	1.44	40	0.06	81	SR5-GRT-1200-EH*		
1800	Holographic (250 nm peak)	1.00	28	0.04	62	SR5-GRT-1800-DH	575	945
1800	Holographic (380 nm peak)	0.93	26	0.04	70	SR5-GRT-1800-FH		
2400	300	0.69	19	0.03	68	SR5-GRT-2400-0300	435	705
2400	Holographic (220 nm peak)	0.74	20	0.03	68	SR5-GRT-2400-BH		
2400	Holographic (400 nm peak)	0.62	17	0.03	73	SR5-GRT-2400-GH		
Mirror	UV-VIS	-	-	-	-	SR5-GRT-MR-AL-MGF2	-	-
Mirror	VIS-NIR	-	-	-	-	SR5-GRT-MR-SILVER	-	-

*Option for minimized scattered light.

Need to have maximum collection efficiency in the NIR/SWIR? All gratings are also available with protected silver coating. Please contact your local representative for further information.

Step 2c - Selecting The Correct Grating Efficiency Option

All graphs shown below represent efficiency for 45° polarisation

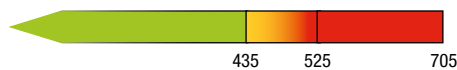
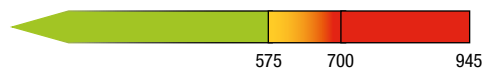
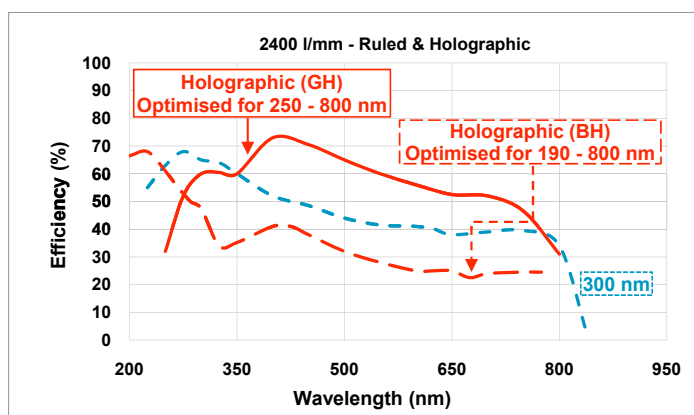
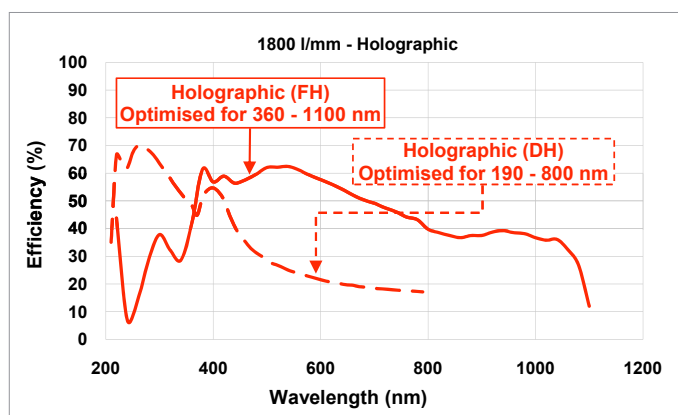
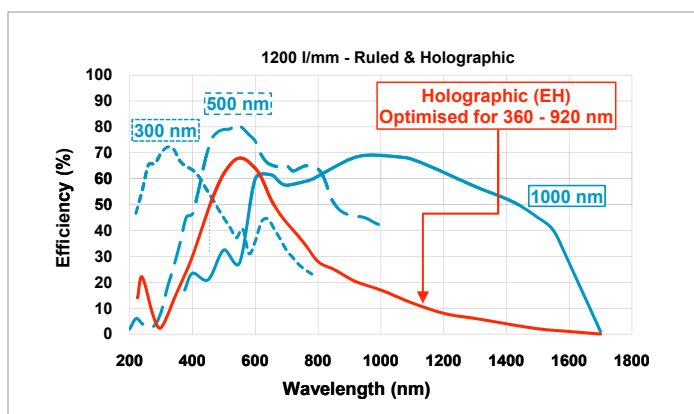
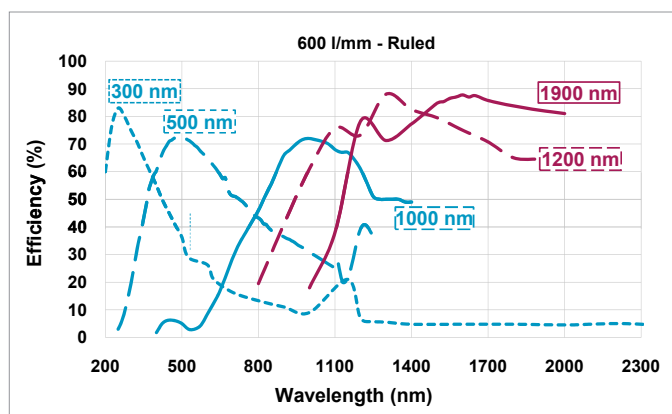
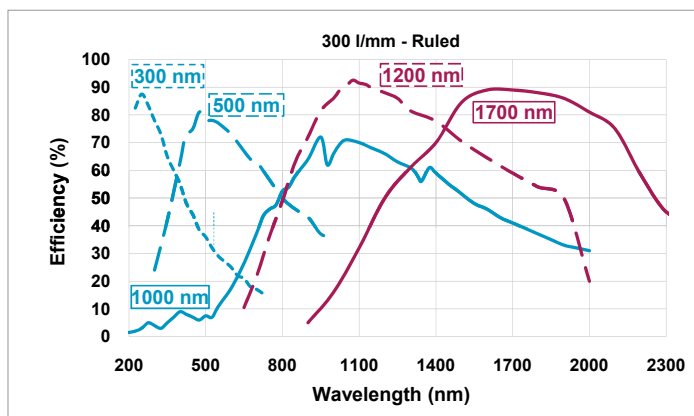
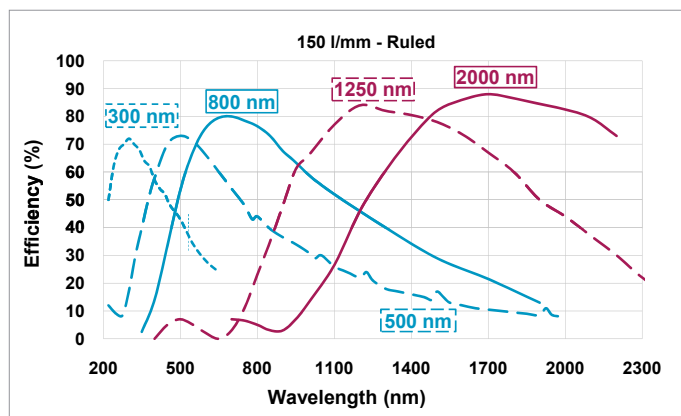

Important Consideration

System throughput is dependent on the grating's angle of operation and may decrease with higher grating operating angles.

Step 3 - Selecting The Correct Light Coupling Interfaces

How to customize the Shamrock 500i (Side Entrance Port):

Side input port (applicable to all models)

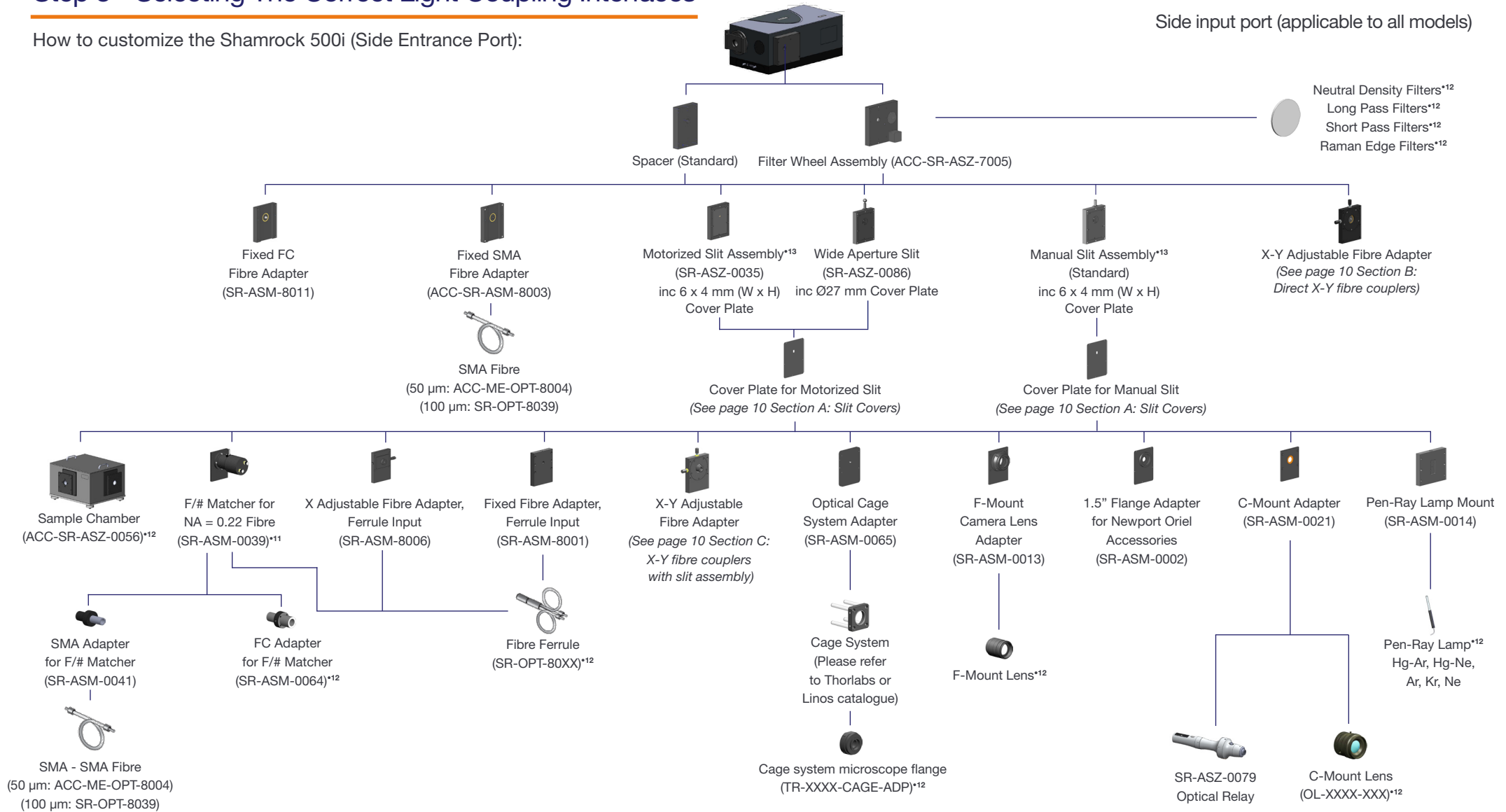

Step 3 - Selecting The Correct Light Coupling Interfaces

How to customize the Shamrock 500i (Direct Entrance Port):



Direct input port (applicable to C & D models)

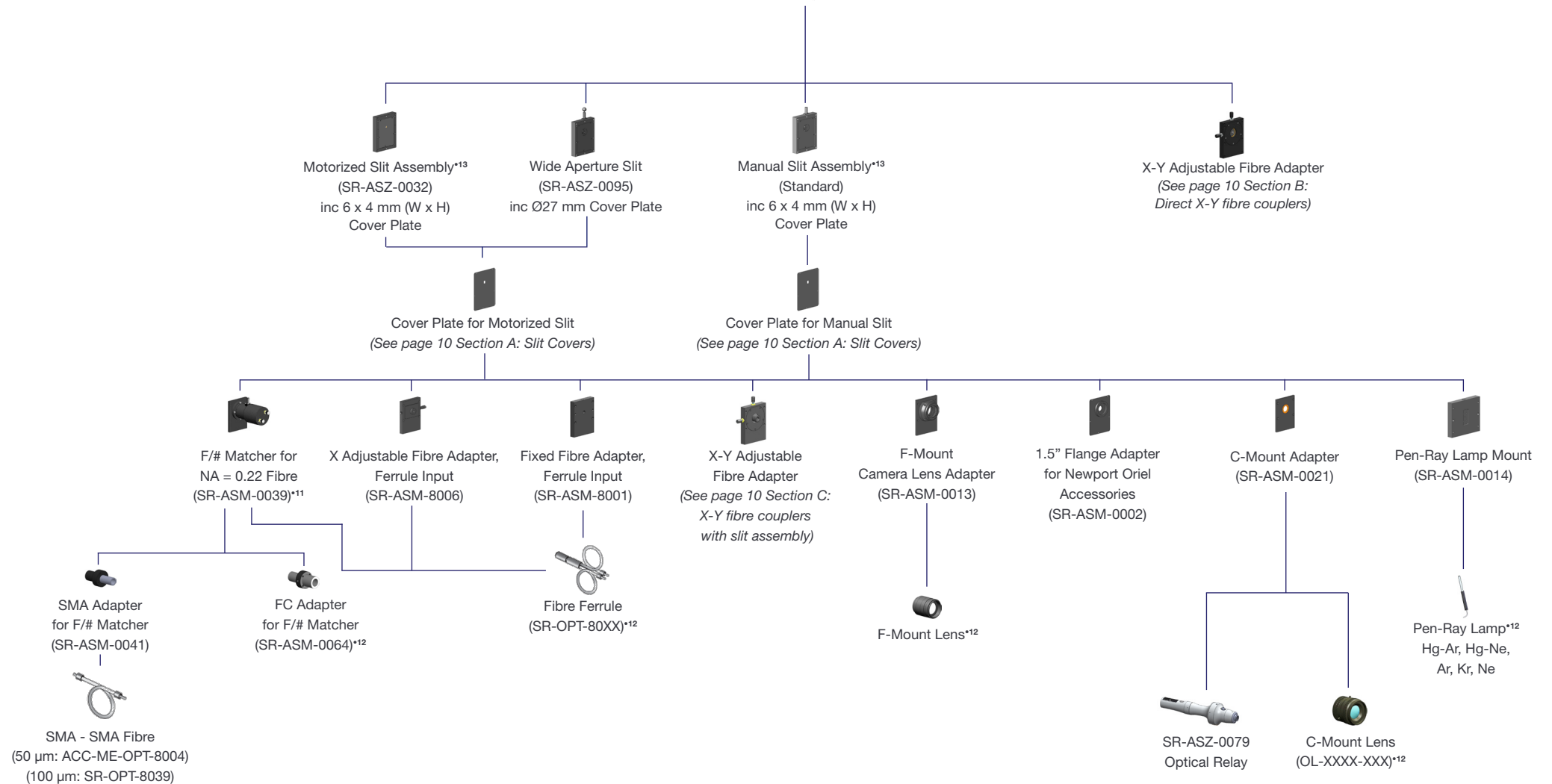

Step 4 - Cameras & Output Port Flanges

How to customize the Shamrock 500i:

Side Output Port (Applicable to B & D models)

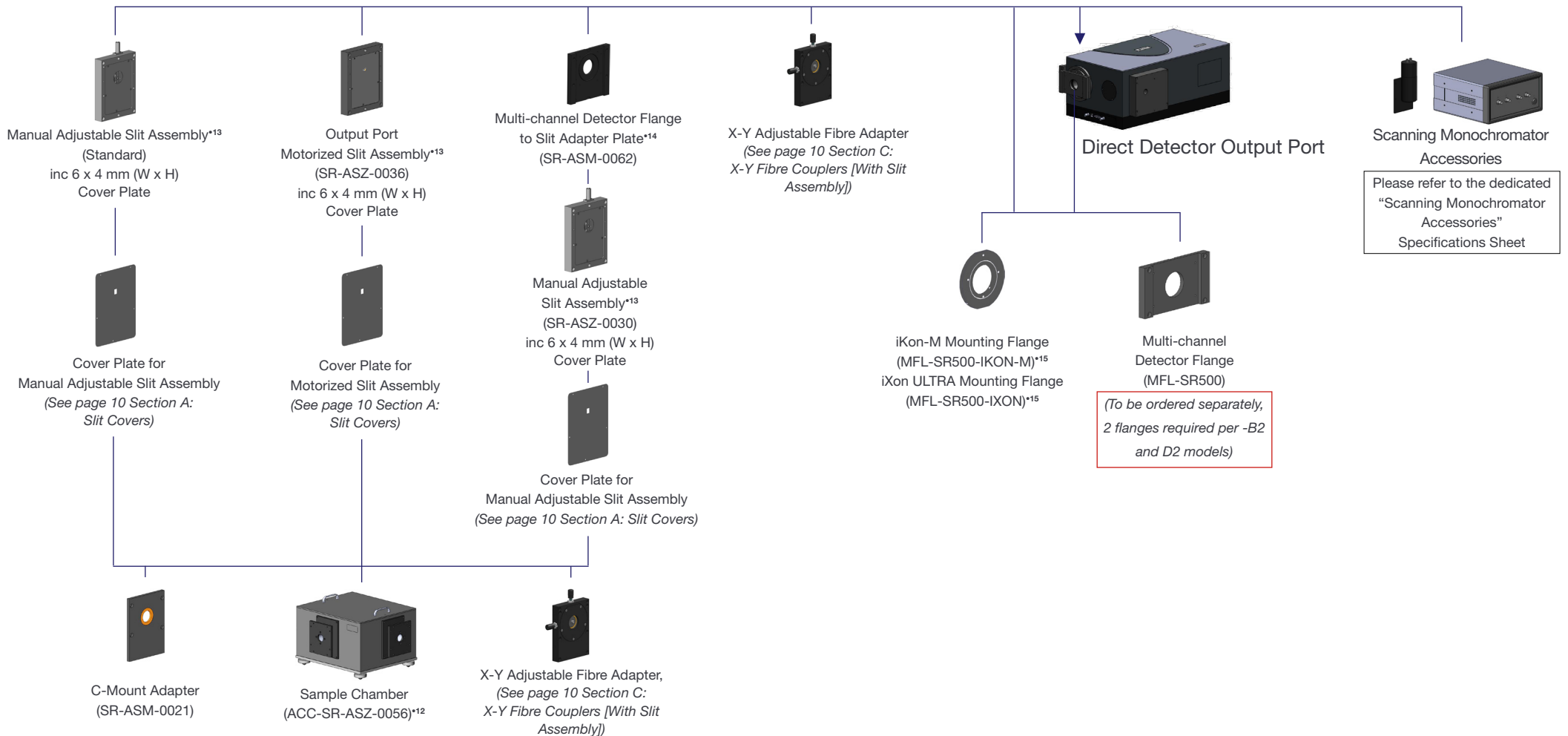

A: Slit Covers

Cover Plate Apertures for Motorized Slit

Part No.	Size
SR-ASM-0016*16	6 x 4 mm (W x H)
SR-ASM-0017	6 x 6 mm (W x H)
SR-ASM-0010	6 x 8 mm (W x H)
SR-ASM-0011	6 x 14 mm (W x H)
SR-ASM-0072*17	Ø 27 mm

Cover Plate Apertures for Manual Slit

Part No.	Size
SR-ASM-0025	6 x 4 mm (W x H)
SR-ASM-0026	6 x 6 mm (W x H)
SR-ASM-0027	6 x 8 mm (W x H)
SR-ASM-0028	6 x 10 mm (W x H)
SR-ASM-0029*16	6 x 14 mm (W x H)
SR-ASM-0100*17	Ø 27 mm

B: Direct X-Y Fibre Couplers

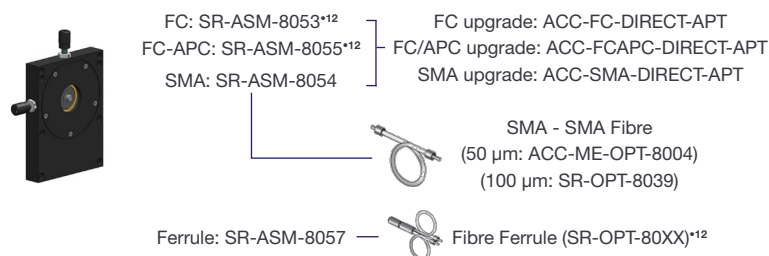

C: X-Y Fibre Couplers (with Slit Assembly)

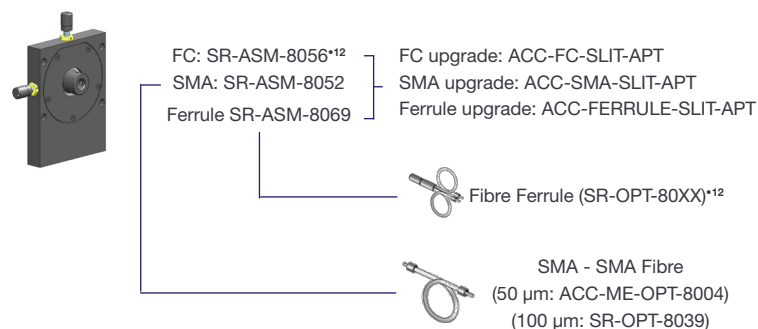

Notes:

- For connection to manual slits, please also order Ø27 mm slit cover plate SR-ASM-0100
- For connection to motorized slits, please also order Ø27 mm slit cover plate SR-ASM-0072

Typical Setup - Spectroscopy

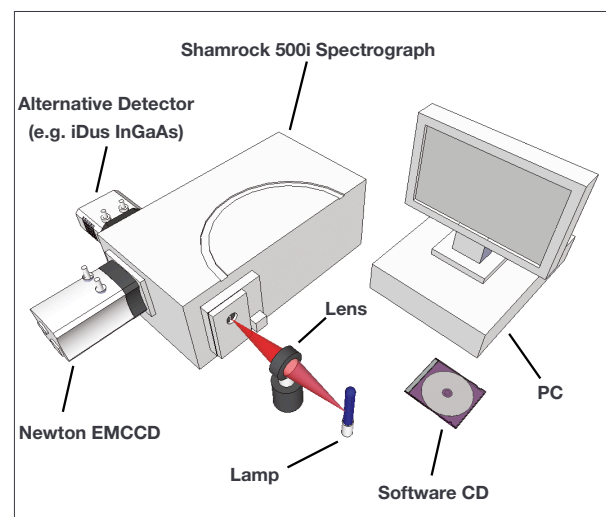

Applications Guide

- Absorption-Transmission-Reflection
- Raman (Stimulated, Resonance, CARS, SERS, SORS, TERS)
- Fluorescence-Luminescence
- Single Molecule Spectroscopy
- Plasma Studies & LIBS
- Plasmonics

Step 5 - Selecting A Software Option

The Shamrock 500i requires at least one of the following software options:

- 1 - **Solis Spectroscopy** A 32-bit and fully 64-bit enabled application for Windows (7, 8, 8.1 and 10) offering rich functionality for data acquisition and processing, as well as Andor cameras, spectrograph and motorized accessories simultaneous control. AndorBasic provides macro language control of data acquisition, processing, display and export.
- 2 - **Standalone Solis Spectroscopy** GUI for standalone spectrograph operation
- 3 - **Shamrock SDK** A software development kit that allows you to control the Andor range of Kymera and Shamrock spectrographs from your own application. Compatible as 32 bit libraries for Windows (7, 8, 8.1 and 10). Compatible with C/C++, C#, VB.NET and LabVIEW for Windows/Linux.
- 4 - **Solis Scanning** Dedicated interface for scanning monochromator acquisitions, including comprehensive experimental set-ups builder. Simultaneous control of single point detector Kymera and Shamrock monochromator and motorized accessories.

Solis Spectroscopy: Dedicated spectroscopy acquisition software

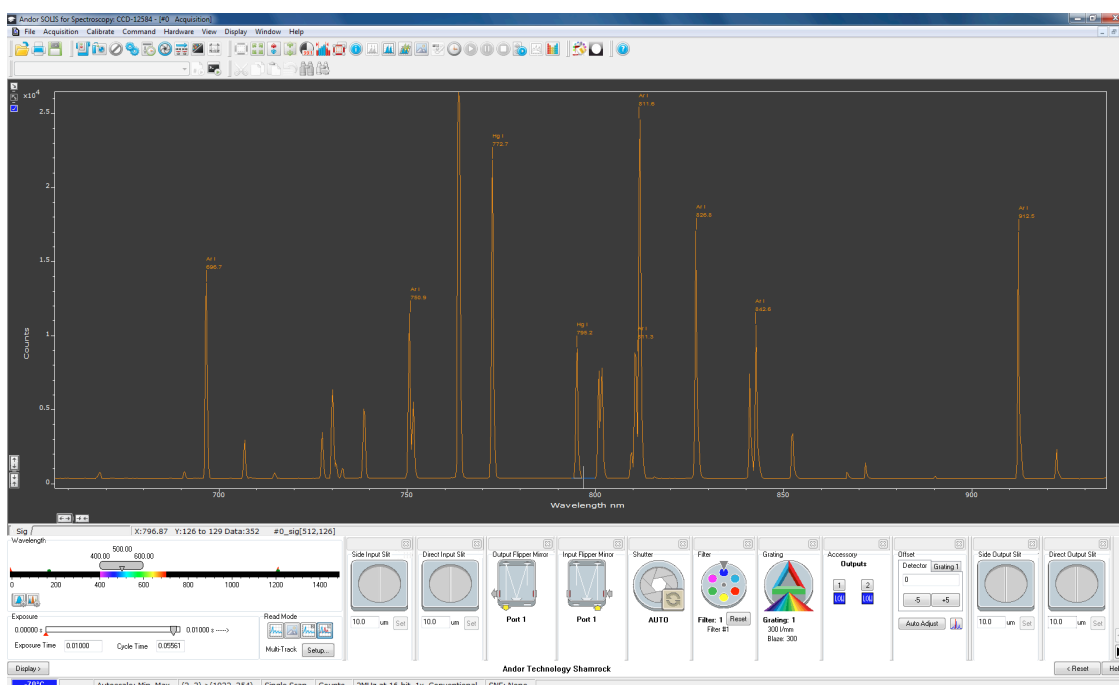

Wavelength drive

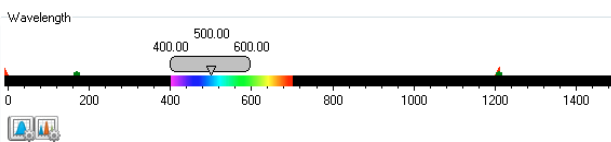

Set the wavelength range for the current grating - drag slider to desired wavelength or just type in appropriate value

Exposure time

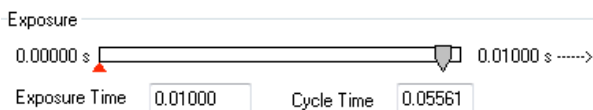

Set the exposure time for the detector - quick access for easy acquisition optimization

Real Time Control

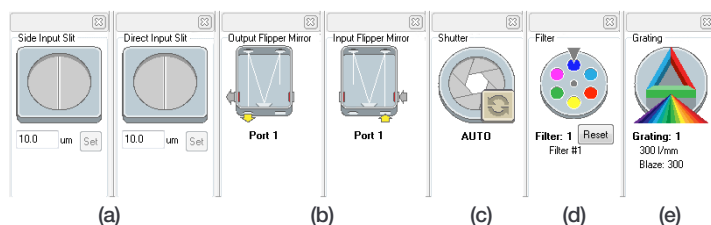

- (a) **Slit drive:** Control the spectrograph slit width - drag blades on icon or type in required slit width
- (b) **Flipper motor:** Used to select the appropriate exit port
- (c) **Shutter:** Synchronization mode selection for shutter operation
- (d) **Filter wheel:** Used to select a particular filter on the filter wheel - just click on the desired filter position
- (e) **Grating turret:** Used for setting grating turret to a new position and bringing desired grating in the optical path - just click on the desired grating

Product Drawings

Dimensions in mm [inches]

Side output applies to SR-500i-B2 model only

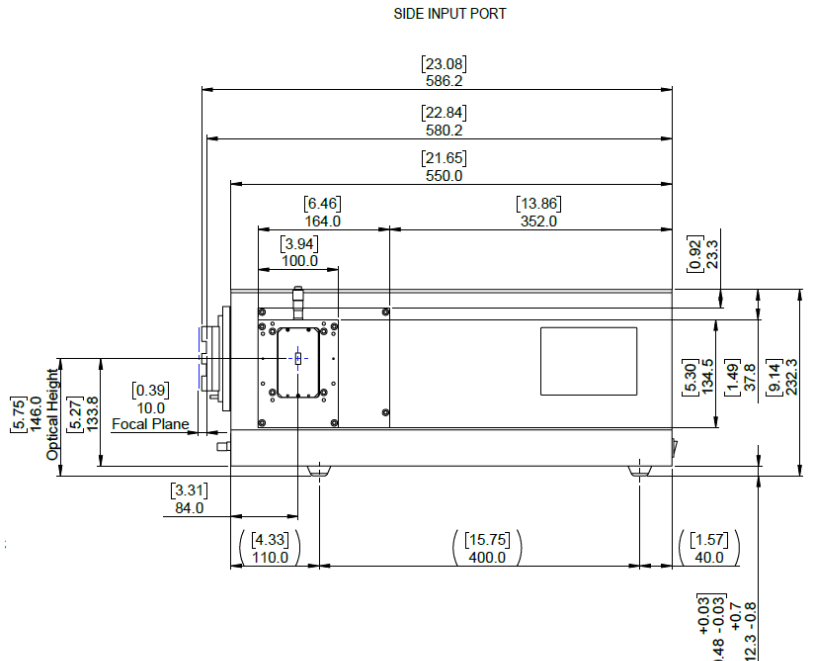
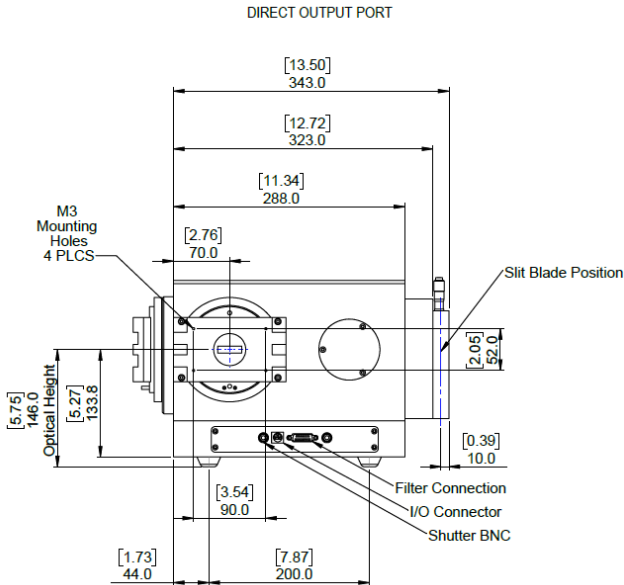
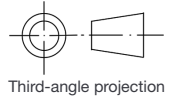

Weight: 25 kg [55.12 lbs approx]

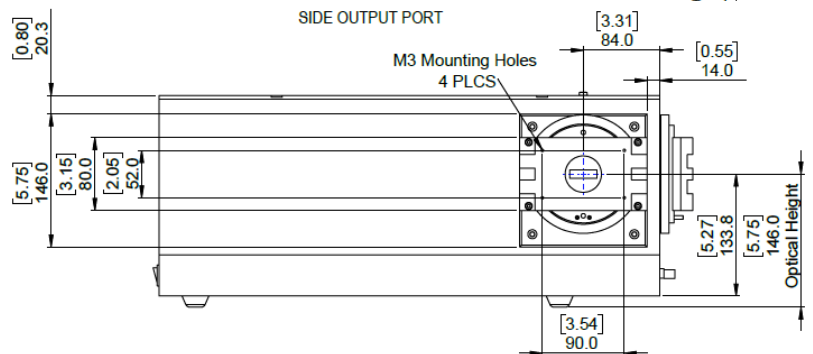

Shutter Specifications

Maximum repetition rate	2 Hz
Minimum open/close time	15 ms
Minimum lifetime	Better than 100K cycles

Optical Property

Focal plane size (mm, W x H)	30 x 14
Stray light *18	
FVB (1 nm from laser)	1.1×10^{-4}
FVB (10 nm from laser)	2.6×10^{-5}
1 mm strip (1 nm from laser)	1.1×10^{-4}
1 mm strip (10 nm from laser)	2.6×10^{-5}

Wavelength Drive Performance

Wavelength accuracy *19 Center	0.04 nm
Wavelength repeatability *20	10 μ m

Wavelength Side Accuracy

Wavelength side accuracy *21	0.05 nm
------------------------------	---------

Optical Axis

The optical path height is shown with standard feet attached.

Screw Type Requirements

CCD flange to Spectrograph flange	4 off, M4 x 16
Camera to CCD flange	4 off, M3 x 10
iXon camera to iXon flange	4 off, M5 x 10, countersunk, hex head

Connecting to the Shamrock 500i

USB Shamrock Control

Connector type: USB 'B' type

Shutter Control

Connector type: BNC Female, 50 Ω



Order Today

Need more information? At Andor we are committed to finding the correct solution for you. With a dedicated team of technical advisors, we are able to offer you one-to-one guidance and technical support on all Andor products. For a full listing of our local sales offices, please see: andor.com/contact

Our regional headquarters are:

Europe

Belfast, Northern Ireland
Phone +44 (28) 9023 7126
Fax +44 (28) 9031 0792

North America

Concord, MA, USA
Phone +1 (860) 290 9211
Fax +1 (860) 290 9566

Japan

Tokyo
Phone +81 (3) 6732 8968
Fax +81 (3) 6732 8939

China

Beijing
Phone +86 (10) 8271 9066
Fax +86 (10) 8271 9055

Items shipped with your spectrograph

- 1x 3 m USB 2.0 cable Type A to Type B
- 1x Power supply with 3 m mains cable
- 1x CD containing Andor user guides
- 1x Individual system performance booklet
- 1x CD containing either Solis software or SDK (if requested at time of order)
- 1x Hex key set (2 mm, 3 mm & 5 mm)

Regulatory Compliance

Compliant with the requirements of the EU EMC and LVD Directives, compliant with the international EMC and safety standards IEC 61326-1 and IEC 61010-1.

Footnotes: Specifications are subject to change without notice

1. In the case of a multiple grating turret order, please specify desired grating configuration for each turret.
2. SR-SHT-9002 calls for 1x shutter. For dual input port options (C, D1 & D2) it is recommended to order a shutter for each port. Shutter operation only requires BNC to SMB cable from USB cameras.
3. Typical values quoted with 27.6 mm wide CCD, e.g. Newton DU940.
4. Typical values quoted with 10 μ m slit and 13.5 μ m pixel CCD, e.g. Newton DU940.
5. Typical values quoted at 500 nm centre wavelength.
6. Typical values quoted at 300 nm centre wavelength.
7. Typical values quoted at maximum efficiency wavelength or blaze wavelength unless otherwise stated.
8. Wavelength within the recommended operating spectral region.
9. Indicative values; the working range of these gratings is principally in the region where optical aberrations may alter the system resolution performance quoted.
10. Values shown are representative of a triple grating system, where resolution has been optimized to give the best performance for the three gratings and across the full recommended wavelength range. Useful signal is assumed to be imaged on the entire height of a 6.9 mm sensor (i.e. Newton DU940) and fully vertically binned.
11. Please refer to F/# matcher specification sheet for magnification considerations.
12. Please refer to the local sales representative or website for further information on available options and complimentary accessories.
13. Slit widths range from 10 μ m to 2.5 mm.
14. For B2 and D2 configurations only - to be ordered separately.
15. Please specify relevant port at time of order.
16. Provided as standard.
17. Recommended for use with fibre-optics and C-mount accessories.
18. Measured with a 633 nm laser and a 1200 l/mm grating for Full Vertical Binning (FVB) on a 6.9 mm high sensor, and a 1 mm strip vertically centred on the optical axis.
19. Average measurements using > 30 calibration lines, covering the recommended grating angle operating range with a 1200 l/mm grating.
20. The standard deviation of 20 measurements of a peak's centre-of-mass position: between each measurement the drive is moved 10x including both wavelength and grating changes to reflect typical use.
21. Side accuracy measured using a 27.6 mm wide sensor, reflecting the dispersion calibration and step-and-glue accuracy.
22. Only Andor CCD platforms (Newton, iDus, iKon) can be controlled in conjunction with Kymera and Shamrock spectrographs in EPICS software



Minimum Computer Requirements:

- 3.0 GHz single core or 2.4 GHz multi core processor
- 2 GB RAM
- 100 MB free hard disc to install software (at least 1 GB recommended for data spooling)
- USB 2.0 High Speed Host Controller capable of sustained rate of 40 MB/s
- Windows (7, 8, 8.1 and 10)

Operating & Storage Conditions

- Operating Temperature: 0°C to 30°C ambient
- Relative Humidity: < 70% (non-condensing)
- Storage Temperature: -25°C to 50°C

Power Requirements

- 100 - 240 VAC 50 - 60 Hz



Windows is a registered trademark of Microsoft Corporation.
Labview is a registered trademark of National Instruments.
Matlab is a registered trademark of The MathWorks Inc.